



  
**ErgoMounts**

**T2 Elite with Paralink  
LCD Wall Mount**



  
**MedicalMounts**

## T2 Elite with Paralink LCD Wall Mount

The T2 Elite with Paralink combination series is a premium hospital / dental LCD TV / monitor and keyboard mounting solution incorporating revolutionary design features allowing monitor weights of up to 12.7kg or monitor and keyboard combinations up to 9.9kg to be supported, whilst providing effortless, finger touch movement.

The T2 Elite with Paralink range has the capacity to extend up to 1730mm (68") from the wall and fold to within 150mm (5.9") when not in use. As a fully cable managed monitor mounting solution, the T2 Elite with Paralink LCD wall mounted monitor arm is ideal in hospital and dental environments.

Available in monitor or combination monitor and keyboard configurations. Select from a wide range of keyboard options including; ergonomic, composite and mini 12" flat. Finishes include medical white, light grey or black.

- Massive 1260mm (49.6") of max reach to front of monitor, massive 1730mm (68") to front of keyboard tray.
- Hard wearing, durable powder coat finish.
- 12.7kg of max weight when used with monitor only.
- 9.9kg of max weight when used with both monitor only and monitor and keyboard combination.
- User friendly ergonomic height and reach adjustment.
- Cables route neatly through the arm.
- Can be cleaned with hospital grade cleaning solutions up to 10,000 parts bleach per 1,000,000.
- Optional components include dedicated mouse pad, gel wrist rest, wall track and barcode scanner.
- Touch screen stable.
- Available in medical white, light grey or black finish.

### Specifications

Arm Ext.:	Up to 110mm
Monitor Height Adjust	130mm
Tilt Adjustment:	+/-45°
Monitor Swivel	+/-90°
Monitor Orientation	Landscape or portrait
Colour	Black, medical white or grey
Touch Screen Stable	Yes
Keyboard and Mouse Tray	Available
Max Monitor Weight	14.5kg
Product Warranty	3 Years (1yr on cylinder)

T +44 (0)1252 333326 F +44 (0)1252 330006  
E sales@ergomounts.co.uk

[www.ergomounts.co.uk](http://www.ergomounts.co.uk) [www.medicalmounts.co.uk](http://www.medicalmounts.co.uk)



24"



1730mm



530mm



-45°



+/-90°



L/P



Black, grey or medical white



Yes



Optional



12.7kg











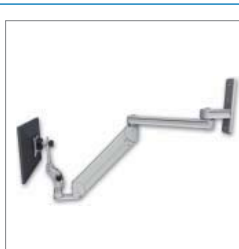

3 Years (1 year on cylinder)





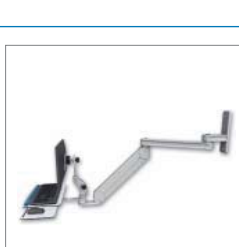

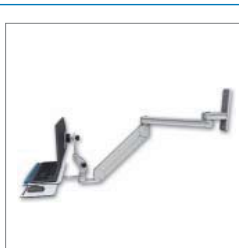

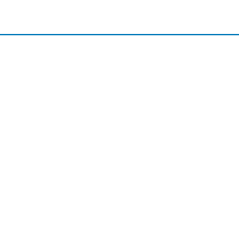



VESA MIS-D  
75x75mm  
100x100mm



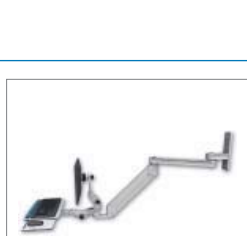

see it your way...

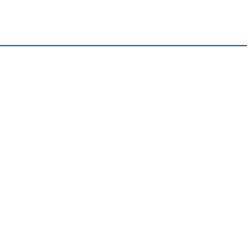

		<b>Part Number</b> <b>EMT2P-WT2-MW</b>	<b>Description</b> T2 Elite LCD arm. Wall Mount. Paralink monitor attachment. Max weight 12.7kg. Medical white finish.
		<b>EMT2P-WT2-QG</b>	T2 Elite LCD arm. Wall Mount. Paralink monitor attachment. Max weight 12.7kg. Light grey finish.
		<b>EMT2P-WT2-TB</b>	T2 Elite LCD arm. Wall Mount. Paralink monitor attachment. Max weight 12.7kg. Black finish.
		<b>EMT2EP-WT2-KUB-MW</b>	T2 Elite LCD arm. Wall Mount. Paralink monitor attachment. Ultra ergonomic keyboard attachment. Ultra keyboard tray. Max weight 9.9kg. Medical white finish.
		<b>EMT2EP-WT2-KUB-QG</b>	T2 Elite LCD arm. Wall Mount. Paralink monitor attachment. Ultra ergonomic keyboard attachment. Ultra keyboard tray. Max weight 9.9kg. Light grey finish.
		<b>EMT2EP-WT2-KUB-TB</b>	T2 Elite LCD arm. Wall Mount. Paralink monitor attachment. Ultra ergonomic keyboard attachment. Ultra keyboard tray. Max weight 9.9kg. Black finish.
		<b>EMT2EP-WT2-KUC-MW</b>	T2 Elite LCD arm. Wall Mount. Paralink monitor attachment. Ultra keyboard attachment. Composite keyboard tray. Max weight 9.9kg. Medical white finish.
		<b>EMT2EP-WT2-KUC-QG</b>	T2 Elite LCD arm. Wall Mount. Paralink monitor attachment. Ultra keyboard attachment. Composite keyboard tray. Max weight 9.9kg. Light grey finish.
		<b>EMT2EP-WT2-KUC-TB</b>	T2 Elite LCD arm. Wall Mount. Paralink monitor attachment. Ultra keyboard attachment. Composite keyboard tray. Max weight 9.9kg. Black finish.



		<b>Part Number</b> <b>EMT2EP-WT2-KU12F-MW</b>	<b>Description</b> T2 Elite LCD arm. Wall Mount. Paralink monitor attachment. Ultra keyboard attachment. Ultra 12" mini flat keyboard tray. Max weight 9.9kg. Medical white finish.
		<b>EMT2EP-WT2-KU12F-QG</b>	T2 Elite LCD arm. Wall Mount. Paralink monitor attachment. Ultra keyboard attachment. Ultra 12" mini flat keyboard tray. Max weight 9.9kg. Light grey finish.
		<b>EMT2EP-WT2-KU12F-TB</b>	T2 Elite LCD arm. Wall Mount. Paralink monitor attachment. Ultra keyboard attachment. Max weight 9.9kg. Black finish.
		<b>EMT2EP-WT2-KPB-MW</b>	T2 Elite LCD arm. Wall Mount. Paralink monitor attachment. Paralink keyboard attachment. Ultra ergonomic keyboard tray. Max weight 9.9kg. Medical white finish.
		<b>EMT2EP-WT2-KPB-QG</b>	T2 Elite LCD arm. Wall Mount. Paralink monitor attachment. Paralink keyboard attachment. Ultra ergonomic keyboard tray. Max weight 9.9kg. Light grey finish.
		<b>EMT2EP-WT2-KPB-TB</b>	T2 Elite LCD arm. Wall Mount. Paralink monitor attachment. Paralink keyboard attachment. Ultra ergonomic keyboard tray. Max weight 9.9kg. Black finish.
		<b>EMT2EP-WT2-KPC-MW</b>	T2 Elite LCD arm. Wall Mount. Paralink monitor attachment. Paralink keyboard attachment. Composite keyboard tray. Medical white finish.
		<b>EMT2EP-WT2-KPC-QG</b>	T2 Elite LCD arm. Wall Mount. Paralink monitor attachment. Paralink keyboard attachment. Composite keyboard tray. Light grey finish.
		<b>EMT2EP-WT2-KPC-TB</b>	T2 Elite LCD arm. Wall Mount. Paralink monitor attachment. Paralink keyboard attachment. Composite keyboard tray. Black finish.

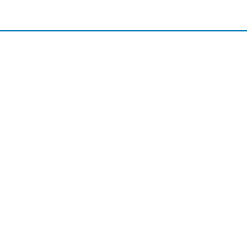

		<b>Part Number</b> <b>EMT2EP-WT2-KP12F-MW</b>	<b>Description</b> T2 Elite LCD arm. Wall Mount. Paralink monitor attachment. Paralink keyboard attachment. Ultra 12" mini flat keyboard tray. Max weight 9.9kg. Medical white finish.
		<b>EMT2EP-WT2-KP12F-QG</b>	T2 Elite LCD arm. Wall Mount. Paralink monitor attachment. Paralink keyboard attachment. Ultra 12" mini flat keyboard tray. Max weight 9.9kg. Light grey finish.
		<b>EMT2EP-WT2-KP12F-TB</b>	T2 Elite LCD arm. Wall Mount. Paralink monitor attachment. Paralink keyboard attachment. Ultra 12" mini flat keyboard tray. Max weight 9.9kg. Black finish.

	<b>EMBICWMPAD</b>	Ergonomic (standard width) keyboard mouse pad. Finished in blue.
	<b>EMB000S540</b>	Gel wrist rest

	<b>EMTMD12</b> <b>EMTMD26</b> <b>EMTMD36</b>	300mm (12") MD aluminium wall track 660mm (26") MD aluminium wall track 910mm (36") MD aluminium wall track
-------------------------------------------------------------------------------------	----------------------------------------------------	-------------------------------------------------------------------------------------------------------------------

	<b>EMTAMD2KIT</b>	Elite track mount adaptor kit
-------------------------------------------------------------------------------------	-------------------	-------------------------------

The T2 Elite with Paralink LCD wall mount is highly adjustable. The internal nitrogen gas cylinder enables users to adjust the height and reach of the attached LCD monitor / TV with ease. In cases of clinical emergencies staff can immediately swing the monitor / TV up and out of the way enabling direct access to the patient.

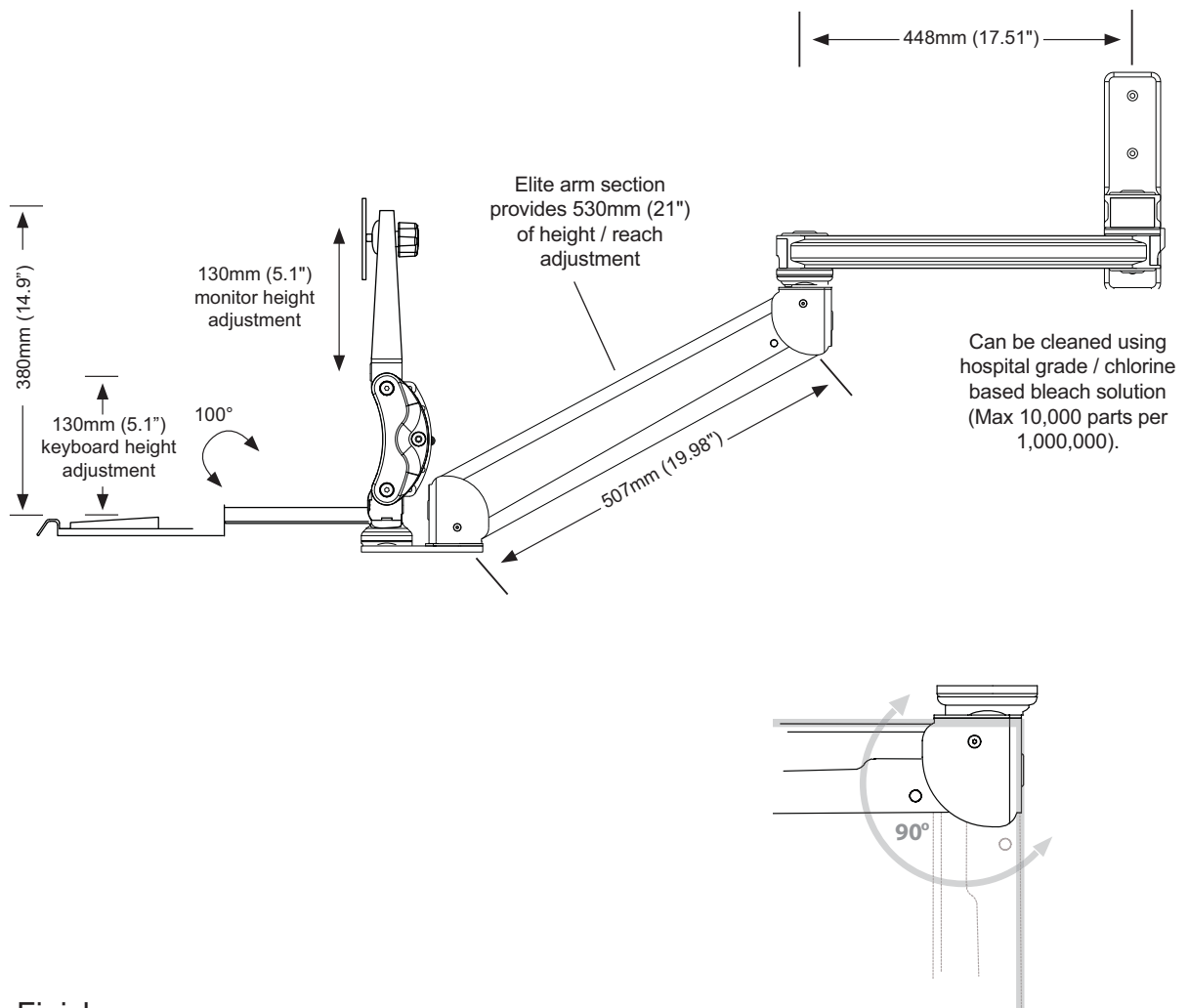

### Finishes



MW  
Medical White



QG  
Light Grey



TB  
Black



see it your way...

T +44 (0)1252 333326 F +44 (0)1252 330006  
E sales@ergomounts.co.uk

[www.ergomounts.co.uk](http://www.ergomounts.co.uk) [www.medicalmounts.co.uk](http://www.medicalmounts.co.uk)

The T2 Elite with Paralink LCD wall mount is highly adjustable. The internal nitrogen gas cylinder enables users to adjust the height and reach of the attached LCD monitor / TV with ease. In cases of clinical emergencies staff can immediately swing the monitor / TV up and out of the way enabling direct access to the patient.

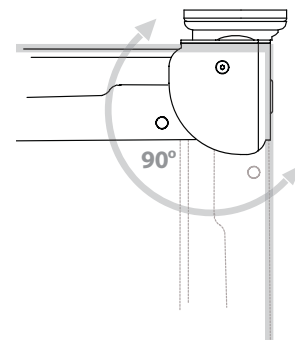
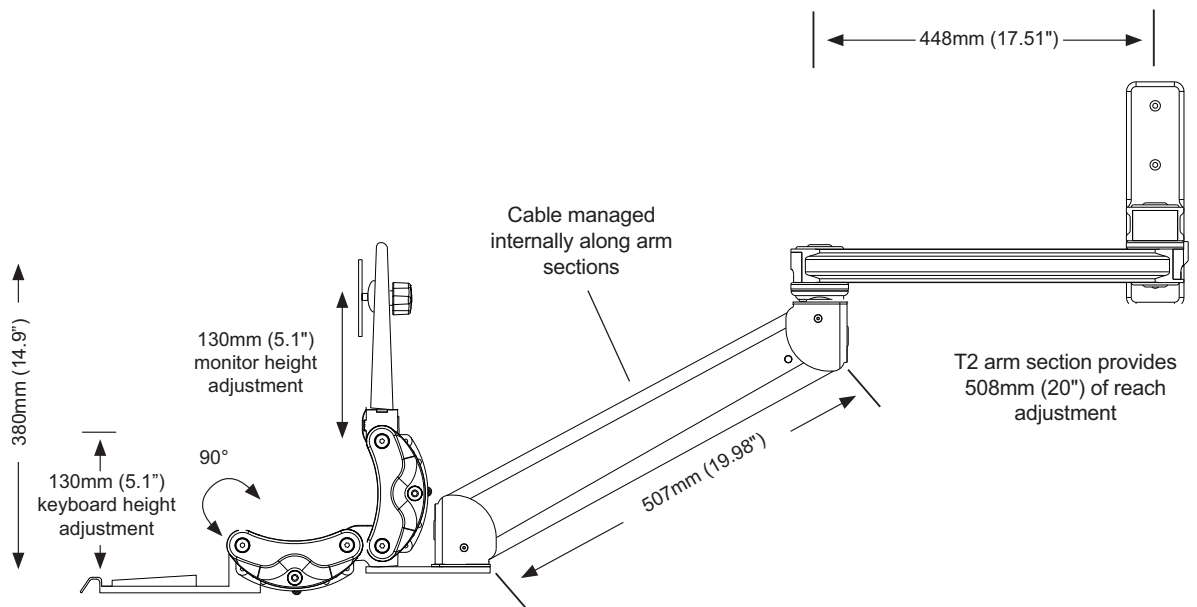

### Finishes





See it your way...

**ErgoMounts** Limited

Unit 10  
Pegasus Court  
North Lane  
Aldershot  
Hampshire  
GU12 4QP  
United Kingdom

T +44 (0)1252 333326  
F +44 (0)1252 330006

[www.ergomounts.co.uk](http://www.ergomounts.co.uk)